

# List of spare parts / accessories Arminia III



model number

- 51.3431.33

model type

- 195713

Replacement parts and accessories can be obtained by quoting the bar code number, article number, order number and serial number used at BURMEIER. The details you require for this can be taken from the type plate which is attached to the inner side of the mattress base frame.

<b>BURMEIER GmbH &amp; Co KG</b> Pivitsheider Straße 270 D - 32791 LAGE ☎ + 49 - 05232 - 9841 - 0		
Model	Arminia III	
Type	195713	
Serie	11 09 F	



The functional security and warranty remain in place if original BURMEIER replacement parts are used! To order replacement parts and/or if you have any questions please contact us at:

**Burmeier GmbH & Co. KG**  
 (A company in the Stiegemeyer Group)  
**Pivitsheider Straße 270 • D - 32791 Lage/Lippe**  
 Tel. : +49 52 32/98 41- 0 • Fax: +49 52 32/98 41- 41  
 Email: service-zentrum@burmeier.de



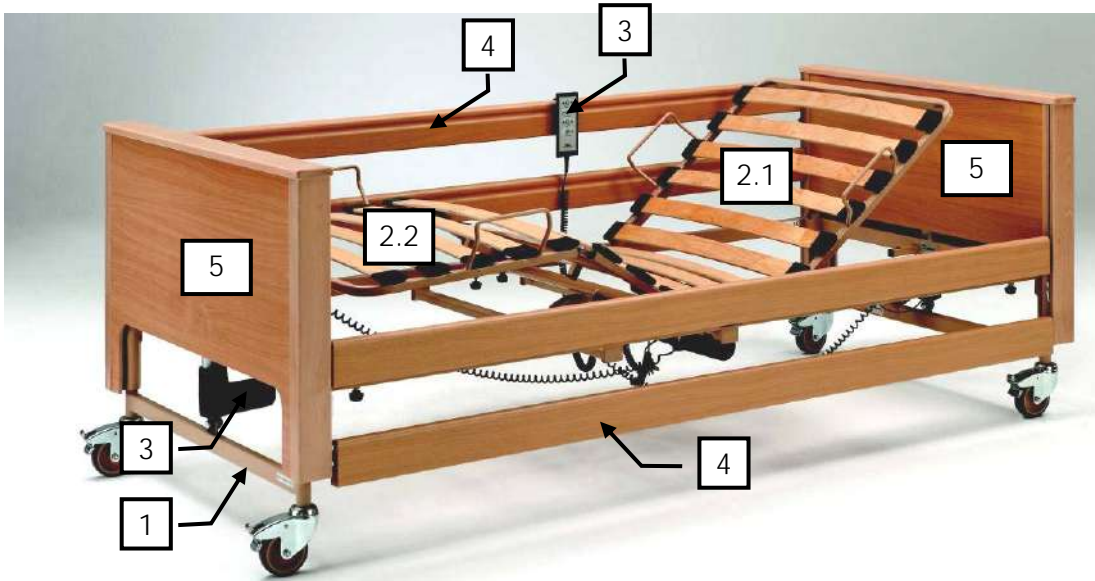

## 1 Replacement parts



Number	Designation	Article no.
<b>1.</b>	<b>chassis head section/foot section</b>	
1.1	chassis complete with motor, without wooden cover	195726
1.2	collar stud for lifting motor, ø 10x35mm	182476
1.3	lock disc (open) for lifting motor, ø 10mm	102555
1.4	lock disc (closed) for lifting motor, ø 10mm	102227
1.5	castor ø 100mm	167036
1.6	screw M10x20mm	101011
1.7	serrated lock disc ø 10,5mm	209395
<b>2.</b>	<b>mattress base, sprung wooden slats</b>	
2.1	mattress base, sprung wooden slats (90 x 200 cm) with motors	195311
	<b>mattress base head section, sprung wooden slats</b>	
2.1.1	½ mattress base head section, sprung wooden slats, without motor	197096
2.1.2	backrest, sprung wooden slats, without motor	171401
2.1.3	sprung wooden slat L: 779mm	152348
2.1.4	sprung wooden slat L: 830mm	205013
2.1.5	holder for sprung wooden slat, plastic	145019
2.1.6	lock disc ø 15mm	167385
2.1.7	black square plug, plastic 20x20x3mm	100105
2.1.8	duct damper splint ø 10x60mm	200395
2.1.9	grip screw M8x18mm	152251
2.1.10	collar stud ø 10x55mm (for back rest/thigh rest motor)	200394
2.1.11	lock disc (open) ø 10mm (for back rest/thigh rest motor)	102555
	<b>mattress base foot section, sprung wooden slats</b>	
2.1.20	½ mattress base foot section, sprung wooden slats, without motor	197097
2.1.21	thigh+lower leg rest (inner frame), sprung wooden slats, without motor	197662
2.1.22	sprung wooden slat L: 779mm	152348

2.1.23	holder for sprung wooden slat, plastic	145019
2.1.24	lock disc ø 15mm	167385
2.1.25	black square plug, plastic 20x20x3mm	100105
2.1.26	grip screw M8x18mm	152251
2.1.27	duct damper splint ø 10x60mm	200395
2.1.28	blind rivet ø 6,4x14mm (connection for thigh/lower leg rest)	179334
2.1.29	washer, metal ø 6,4mm	106043
2.1.30	ratchet, short	169827
2.1.31	lock disc ø 8mm (for ratchet)	106067
2.1.32	self-adhesive white stripe 1000x18x1mm	192516
	<b>mattress base, metal slats</b>	
2.2	mattress base, metal slats (90 x 200 cm) with motors	195315
	<b>mattress base head section, metal slats</b>	
2.2.1	½ mattress base head section, metal slats , without motor	197664
2.2.21	backrest, metal slats, without motor ( <i>former model</i> )	169808
2.2.22	follow-up model ( <i>up to year of manufacture 10/2010</i> )	209521
2.2.3	lock disc ø 15mm	167385
2.2.4	black square plug, plastic 20x20x3mm	100105
2.2.5	grip screw M8x18mm	152251
2.2.6	duct damper splint ø 10x60mm	200395
2.2.7	collar stud ø 10x55mm (for back rest/thigh rest motor)	200394
2.2.8	lock disc (open) ø 10mm (for the back rest/thigh rest motor)	102555
	<b>mattress base foot section, metal slats</b>	
2.2.20	½ mattress base foot section, metal slats , without motor	197666
2.2.21	thigh+lower leg rest(inner frame),metal slats,without motor	197663
2.2.22	lock disc ø 15mm	167385
2.2.23	black square plug, plastic 20x20x3mm	100105
2.2.24	grip screw M8x18mm	152251
2.2.25	duct damper splint ø 10x60mm	200395
2.2.26	blind rivet ø 6,4x14mm (connection for thigh/lower leg rest)	179334
2.2.27	washer, metal ø 6,4mm	106043
2.2.28	ratchet, short	169827
2.2.29	lock disc ø 8mm (for ratchet)	106067
2.2.30	self-adhesive white stripe 1000x18x1mm	192516
<b>3.</b>	<b>drive system</b>	
3.1	hand control with locking function	165527
3.1.1	hook for hand control	158919
3.2	locking key	167882
3.3	CB06 control unit	160718
3.3.1	cable comb	158223
3.3.2	fastening clamp for control unit	160880
3.4	power cable	156131
3.5	motor cable D-270 (back rest)	151144
3.6	motor cable D-200 (thigh rest)	151143
3.7	motor cable D-400 (height)	153199
3.8	back rest motor	184853
3.9	thigh rest motor	151761
3.10	lifting motor	153198
<b>4.</b>	<b>side rails</b>	
4.1	side rail guidance	191196
4.2	wooden side rail bar, 95,5 mm	191245

<b>5.</b>	<b>wooden cover</b>	
5.1	wooden cover ( <i>not longer available</i> ) wooden cover ( <i>successor model</i> )	195734 213320
5.1.1	packet of wooden covers(2 pieces) <i>not longer available</i> packet of wooden covers(2 pieces) <i>successor model</i>	195704 210391
5.2	spax screw 4x20mm	160634
5.3	metal guide rail for side rails 615 mm ( <i>until year of manufacture 12/2010</i> )	201937
5.4	metal guide rail for side rails 615 mm ( <i>up to year of manufacture 01/2011</i> )	213521
5.5	spax screw 3x25mm for fastening metal guide rail	145380
5.6	lower release bolt for side rail guidance	220433
5.7	spring for release bolt	150146
<b>6.</b>	<b>lifting pole (incl. grab handle)</b>	146602
6.1	lifting pole without grab handle	160802
6.2	grab handle ( <i>former model</i> ) <i>not longer available</i> grab handle ( <i>former model</i> ) <i>not longer available</i> grab handle ( <i>successor model</i> )	194667 210417 222225
6.3	lifting pole end cap, topas	182111

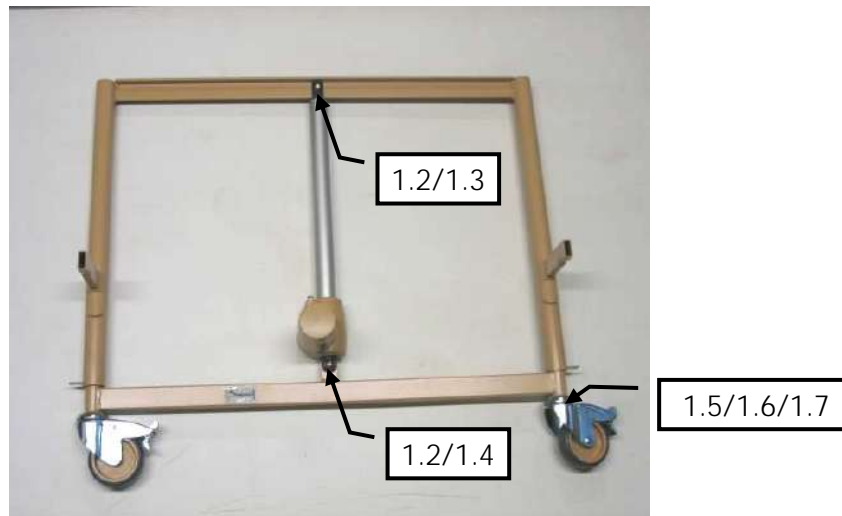
**1. chassis head section / foot section**



		
<p>1.1 chassis complete with motor, without wooden cover 195726</p>	<p>1.2 collar stud for lifting motor, Ø 10x35mm 182476</p>	<p>1.3 lock disc (open) for lifting motor, Ø 10mm 102555</p>

		
<p>1.4 lock disc (closed) for lifting motor, Ø 10mm 102227</p>	<p>1.5 castor Ø 100 mm 167036</p>	<p>1.6 screw M10x20mm 101011</p>





<p>1.7 serrated lock disc Ø 10,5mm 209395</p>



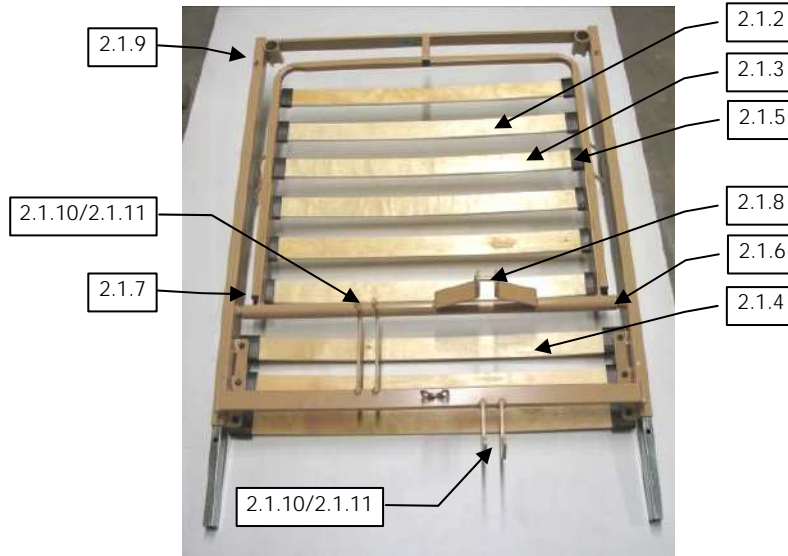

## 2. mattress base, sprung wooden slats



### ½ mattress base head section, sprung wooden slats, without motor



		
2.1.1 ½ mattress base head section, sprung wooden slats, without motor 197096	2.1.2 back rest, sprung wooden slats, without motor 171401	2.1.3 sprung wooden slat L: 779mm 152348

		
2.1.4 sprung wooden slat L: 830mm 205013	2.1.5 holder for sprung wooden slat, plastic 145019	2.1.6 lock disc, metal Ø 15mm 167385



		
2.1.7 black square plug, plastic 20x20x3mm 100105	2.1.8 duct damper splint Ø 10x60mm 200395	2.1.9 grip screw M8x18mm 152251

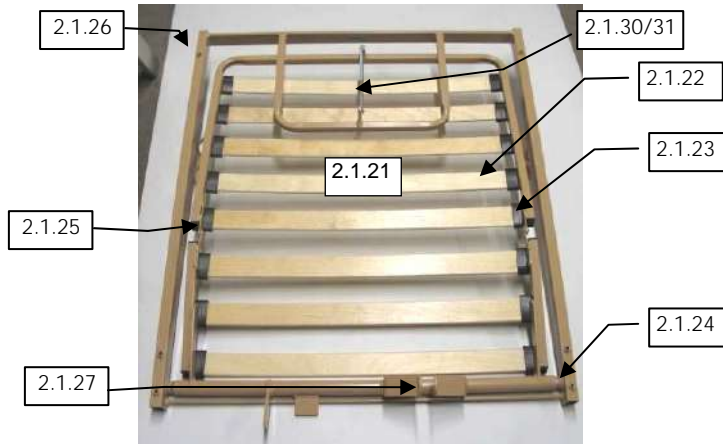

	
2.1.10 collar stud Ø 10x55mm (for back rest/thigh rest motor) 200394	2.1.11 lock disc (open) Ø 10mm (for back rest/thigh rest motor) 102555

**2. mattress base, sprung wooden slats**

**½ mattress base foot section, sprung wooden slats, without motor**



		
2.1.20 ½ mattress base foot section, sprung wooden slats, without motor 197097	2.1.21 thigh+lower leg rest (inner frame), sprung wooden slats, without motor 197662	2.1.22 sprung wooden slat L: 779mm 152348

		
2.1.23 holder for sprung wooden slat, plastic 145019	2.1.24 lock disc Ø 15mm 167385	2.1.25 black square plug, plastic 20x20x3mm 100105

		
2.1.26 grip screw M8x18mm 152251	2.1.27 duct damper splint Ø 10x60mm 200395	2.1.28 blind rivet Ø 6,4x14mm, (connection for thigh/lower leg rest) 179334

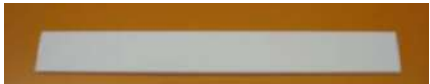

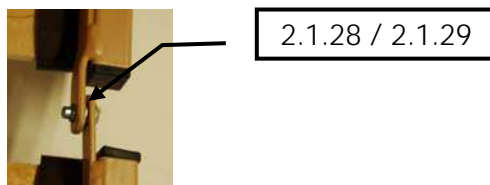
			
2.1.29 washer, metal Ø 6,4mm 106043	2.1.30 ratchet, short 169827	2.1.31 lock disc Ø 8mm (for ratchet) 106067	2.1.32 self-adhesive white stripe 1000x18x1mm 192516





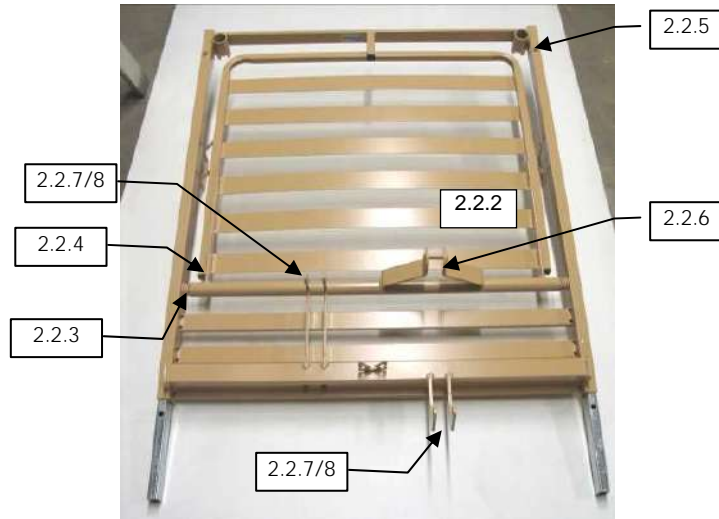



## 2. mattress base, metal slats

### ½ mattress base head section, metal slats, without motor



		
<p>2.2.1 ½ mattress base head section, metal slats, without motor 197664</p>	<p>2.2.21 back rest, metal slats, without motor (former model) 169808</p>	<p>2.2.22 follow-up model, metal slats, without mot. (up to year of manufacture 10/2010) 209521</p>

		
<p>2.2.3 lock disc Ø 15mm 167385</p>	<p>2.2.4 black square plug, plastic 20x20x3mm 100105</p>	<p>2.2.5 grip screw M8x18mm 152251</p>

		
<p>2.2.6 duct damper splint Ø 10x60mm 200395</p>	<p>2.2.7 collar stud Ø 10x55mm (for back rest/thigh rest motor) 200394</p>	<p>2.2.8 lock disc (open) Ø 10mm (for back rest /thigh rest motor) 102555</p>



**2. mattress base, metal slats**

**½ mattress base foot section, metal slats, without motor**

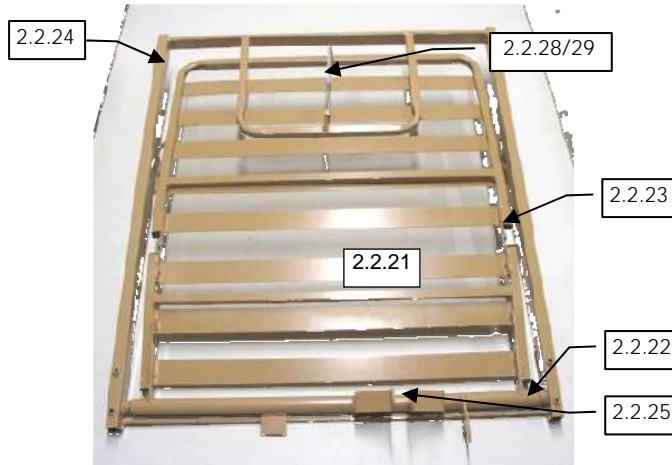

		
2.2.20 ½ mattress base foot section, metal slats, without motor 197666	2.2.21 thigh+lower leg rest (inner frame), metal slats, without motor 197663	2.2.22 lock disc Ø 15mm 167385





		
2.2.23 black square plug, plastic 20x20x3mm 100105	2.2.24 grip screw M8x18mm 152251	2.2.25 duct damper splint Ø 10x60mm 200395

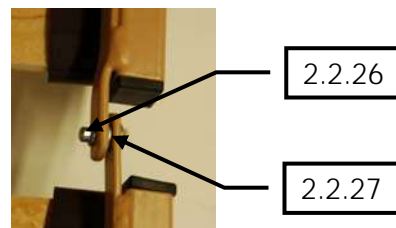

		
2.2.26 blind rivet Ø 6,4x14mm, (connection for thigh/lower leg rest) 179334	2.2.27 washer, metal Ø 6,4mm (connection for thigh/lower leg rest) 106043	2.2.28 ratchet, short 169827



	
2.2.29 lock disc Ø 8mm (for ratchet) 106067	2.2.30 self-adhesive white stripe 1000x18x1mm 192516



### 3. drive system

			
3.1 hand control with locking function 165527	3.1.1 hook for hand control 158919	3.2 locking key 167882	3.3 CB06 control unit 160718

		
3.3.1 cable comb 158223	3.3.2 fastening clamp for control unit 160880	3.4 power cable 156131

		
3.5 motor cable D-270 (back rest) 151144	3.6 motor cable D-200 (thigh rest) 151143	3.7 motor cable D-400 (height) 153199

		
3.8 back rest motor Linak LA27 184853	3.9 thigh rest motor 151761	3.10 lifting motor 153198

### 4. side rails

	
4.1 side rail guidance 191196	4.2 wooden side rail bar, 95,5 mm 191245

**5. wooden cover**

		
5.1 wooden cover 213320	5.2 spax screw 4x20mm 160634	5.3 metal guide rail for side rails 615 mm (until year of manufacture 12/2010) 201937

			
5.4 metal guide rail for side rails 615 mm (up to year of manufacture 01/2011) 213521	5.5 spax screw 3x25mm for fastening metal guide rail 145380	5.6 lower release bolt f. side rail guidance 220443	5.7 spring for release bolt 150146

differences in the metal guide rails for side rails

above

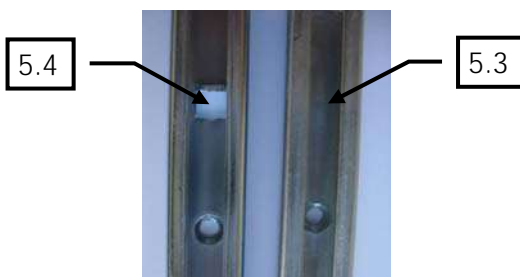

below

**6. lifting pole (incl. grab handle)**

		
6.1 lifting pole without grab handle 160802	6.2 grab handle 222225	6.4 lifting pole end cap, topas 182111

## 2 Accessories

Number	Designation	Article no.
a	lifting pole with grab handle	146602
b	clamp-on extra-high side rail	191367
c	padded side rail cover for 2-bar side rail	156788
d	serving tray to lay on wooden side rails	174296
e	bed extension with sprung wooden slats, approx.20 cm, incl. 4 longer wooden side rail bars	1x 143279 / 4x 198167
f	bed extension with metal slats, approx.20 cm, incl. 4 longer wooden side rail bars	1x 158991/ 4x 198167
g	reading lamp attached to the lifting pole by a claw	175591/174231
h	reading lamp integrated in existing lifting pole sleeve	196221
i	storage/ and transport kit	176432
j	infusion holder (5200-28-50)	116354
k	padded part 900x210x120mm for bed extension	144842
l	bed leaving aid	175402

published by:

Burmeier GmbH & Co. KG  
(A company in the Stieglmeyer Group)

Pivitsheider Straße 270 • D - 32791 Lage/Lippe

Tel. : 0 52 32/98 41- 0 • Fax: 0 52 32/98 41- 41

[www.burmeier.de](http://www.burmeier.de)

Email: [service-zentrum@burmeier.de](mailto:service-zentrum@burmeier.de)



Reprinting, even excerpts, is only permitted with prior written authorization  
from the publisher!

All rights and technical changes reserved