



**MALMET (AUSTRALIA)  
PTY LTD**

**Head Office and Customer Service**  
ABN 95 001 717 791  
9-11 McKay Avenue  
PO Box 373  
Leeton NSW 2705  
Phone: +61 2 6953 7677  
Email: info@malmet.com.au

## ***Drying Cabinet with Timer***

**Model DC12M**

***For Mines***



## ***Operation, Maintenance and Installation Manual***

**Note: Due to Malmet's Policy of continuous product improvement;  
design and technical specifications are subject to change without notice**

Serial Number:	Purchased from:
Date Installed:	Installed by:

It is important that the name from whom you purchased your device and the name of the installer are recorded above. The installer is responsible for the correct installation, start up and demonstrating the operation of this device. They are also responsible for issuing relevant certificates of compliance (these may differ from state to state).



# Table of Contents

Foreword .....	2
Certifications and Compliances .....	2
Quality Policy .....	2
Important Warranty Reminder .....	2
Malmet Head Office and Factory Contact Details .....	2
Safety Instructions - Warnings .....	3
1.0 Design Parameters .....	4
1.1 Device Operation .....	5
1.2 Control Display Features .....	5
1.3 Operating Features .....	6
1.4 Changing the set temperature (lock out feature) .....	7
1.5 Setting the Timer .....	7
<i>To Set Timer</i> .....	7
1.6 Display Errors.....	8
1.7 Typical Loading System .....	9
2.0 Installation .....	10
2.1 Service Connections .....	11
2.2 Device Dimension and Clearances.....	11
2.3 Wall Recessed Devices .....	11
3.0 Maintenance .....	13
3.1 Preventative Maintenance.....	13
3.2 Trouble Shooting Guide .....	13
4.0 Technical Specification .....	14
4.1 Device Specifications .....	14
4.2 Wiring Diagram DC12M .....	15
Warranty Statement .....	16



## Foreword

To obtain maximum life and efficiency from your Malmart Drying Cabinet and to ensure safe operation, please read this manual thoroughly and follow all instructions before operating the device.

This manual provides information on the operation of the device. It is recommended that all persons operating the device have access to this manual for training purposes.

This device is not intended for use by any person without the proper training, experience or knowledge.

The specifications supplied in this manual were in effect at the time of publication. However, owing to Malmart (Australia)'s policy of continuous improvement, changes to these specifications may be made at any time without notice on the part of Malmart (Australia).

## Certifications and Compliances

ARTG Registration Number:	188763 Class 1
Electrical Safety:	Certificate of suitability CS11149N AS/NZS 60335.1:2020
EMC Compliance:	IEC 60601-1-2 Ed 4.0 Emissions CISPR11

## Quality Policy

Malmart's quality management system is certified to ISO 9001:2015 and ISO 13485:2016 and guarantees the quality of this product.

## Important Warranty Reminder

Should you have any problems with your device, contact the company from whom you purchased it, or Malmart (Australia) Pty Ltd.

It is important that the name from whom you purchased your device and the name of the installer are recorded on the front page of this manual. The installer is responsible for the correct installation, start up and demonstrating the operation of this device. They are also responsible for issuing relevant certificates of compliance (these may differ from state to state).

## Malmart Head Office and Factory Contact Details

### **Malmart (Australia) Pty Ltd**

9-11 McKay Avenue  
PO Box 373  
LEETON NSW 2705

Telephone: +61 2 6953 7677

E-mail: [info@malmart.com.au](mailto:info@malmart.com.au)









Website: [www.malmart.com.au](http://www.malmart.com.au)



## **Safety Instructions - Warnings**

*Please read and understand this manual before using this device, if this device is used in a manner not specified by the manufacturer protection by the device may be impaired.*

Please refer to this manual for information wherever this warning symbol is displayed - 

-  **Be aware of 240 Voltage.**
-  **Disconnect power when serving.**
-  **Mains power GPO must be in an accessible position so device can be isolated from mains power during service.**
-  **If the supply cord is damaged it must be replaced by a special cord or assembly from the manufacturer or its service agent.**
-  **Do not overload shelves.**
-  **Do not obstruct Air Inlets or hot air outlet.**
-  **All cabinets should be located on a level floor surface and should never be operated on a sloping surface.**
-  **Install temperature probes, Thermostat over temp limiter and element thermal over temperature cut-out correctly.**
-  **Place instruments and utensils upside down where applicable.**



## 1.0 Design Parameters

The Drying Cabinet is designed to dry surgical instruments and metalware, respiratory tubes or other tubing, face masks, anaesthetic bags and other ancillary equipment modified for Mines.

A total of three (3) stainless steel shelves is provided (1 standard and 2 modified). The shelves are removable, with 3 positions including the base.

The Drying Cabinet is insulated with 25mm approved insulation.

Magnetic door latches are fitted with toughened bi-parting glass doors and gasket to ensure effective seal when the doors are closed.

All external panels are fabricated from satin finish stainless steel 0.9mm thick, 304/4 type.

A centrifugal fan is provided to circulate air throughout the chamber with a filtered air inlet duct on the RH side of unit

A solenoid operated damper is provided to allow damp air to be exhausted from the chamber. An inlet for make-up air is provided.

The heating bank (located in the air duct leading to the chamber) is controlled by a micro-processor, which is factory set to 50°C.

The temperature of the air in the chamber is indicated on the controller mounted on the front panel.

Heating element over temperature cut out protection.



## 1.1 Device Operation

### NOTE

The Drying Cabinet is factory set to 50°C

### Before starting the Device

The Drying Cabinet should be run initially on a power supply not protected by an earth leakage circuit breaker for approximately three hours. This will allow any moisture in the heaters to dry out. The Drying Cabinet can then be connected to an earth leakage circuit breaker protected circuit if required.

Plug into standard 15A 240V outlet.



Note: The Drying Cabinet is recommended for use in a controlled temperature environment.

### Starting the Device

Press the Power ON button on the display, the pre-set temperature of the cabinet appears for approximately five seconds. After five seconds the unit switches to display the actual cabinet temperature and will heat to the set target temperature

## 1.2 Control Display Features





### 1.3 Operating Features



Power ON / OFF



UP and DOWN Temperature Buttons



CYCLE START



“TIME SET” to advance the hrs or Mins

“TIME SELECT” for Hrs or Mins



DISPLAY



### 1.4 Changing the set temperature (lock out feature)

#### **AUTHORISED PERSONNEL ONLY**

Authorised operators can change the temperature by holding the up and down temperature buttons at the same time for a total of 5 seconds. The temperature can then be adjusted. The setting will revert back to tamper proof 5 seconds after the temperature is adjusted or if the up and down temperature buttons are not pressed within 5 seconds.

The Drying Cabinet has a built in electronic over temperature cut out which will switch off the elements if the selected temperature is exceeded by 5°C, and 'Ot' will flash on the display panel. (See Fig 1)

Thermostat Over Temperature Limiter

Note: This safety cut out is an automatic reset device.

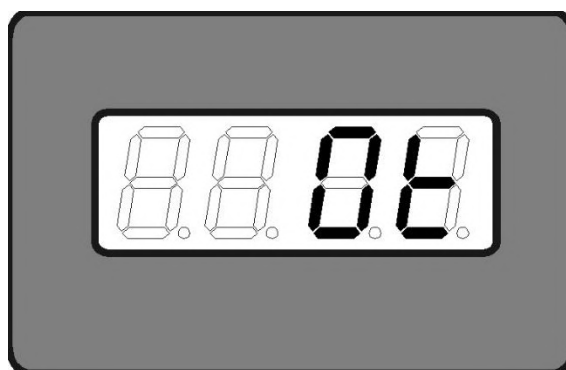

Fig 1

### 1.5 Setting the Timer

Load the Drying Cabinet chamber with components (refer to Diagram A: Typical Loading System).

Press 'Power On' and Set Timer.

#### **To Set Timer**

- 1) Press 'Time Select'. The first digit will begin to flash (hour first)
- 2) Use 'Time Set' to advance the hours (0-6 hours).
- 3) Press 'Time Select' again. The second digit will flash (minutes x 10).
- 4) Use 'Time Set' to advance minutes in tens.
- 5) Press 'Time Select' again. The third digit will flash (minutes x 1)
- 6) Use 'Time Set' to advance minutes.

Note: Time may only be adjusted before 'Cycle Start' key is pressed.





Wait 5 seconds until all 3 digits are flashing in unison. Press 'Cycle Start'. Once 'Cycle Start' is pressed, 'Time Select' is locked out.

To reset 'Time Select' turn off unit and repeat steps 1 to 6.

Once 'Cycle Start' is pressed, the timer will start counting back. When the unit reaches its set temperature (50°C) the display will stop flashing to indicate count down.

If a buzzer sounds when the unit reaches 50°C then 'Time Select' was not pressed after setting the time. Press 'Time Select'.

At completion of cycle, timer panel will display 'END'. (See Fig 2)

**NOTE:** For next cycle, 'Time Select' will resort to default setting unless reset to another time setting.

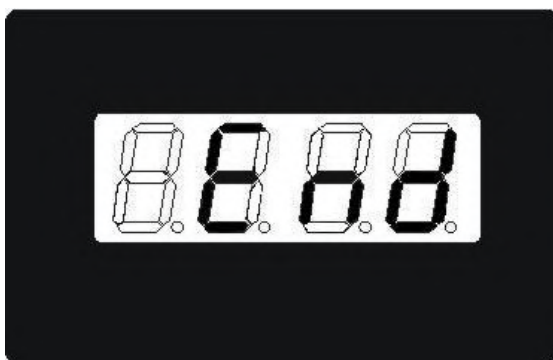

**Fig 2**

### 1.6 Display Errors

If there is an error a buzzer will sound and 'Err' will be displayed on timer board. (See Fig 3)

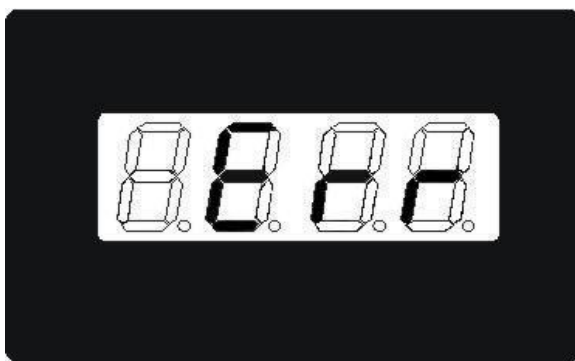

**Fig 3**

The error could be one of the following:

<b>Problem</b>	<b>Suggested Remedy</b>
Temperature drops by 10°C during cycle	Turn Drying Cabinet off and restart cycle. If problem reoccurs, switch off power supply at main and call for Service.
Door is opened during cycle and temperature drops 10°C.	Turn Drying Cabinet off and restart. Press Cycle Start.



### 1.7 Typical Loading System

Place instruments and utensils upside down where applicable.



Diagram A



## 2.0 Installation

The Drying Cabinet must be installed level on adjustable legs.

### Risk Assessment

It is recommended a risk assessment is conducted by the user both prior to and after installation and any risks identified mitigated to an acceptable level using the hierarchy of control;

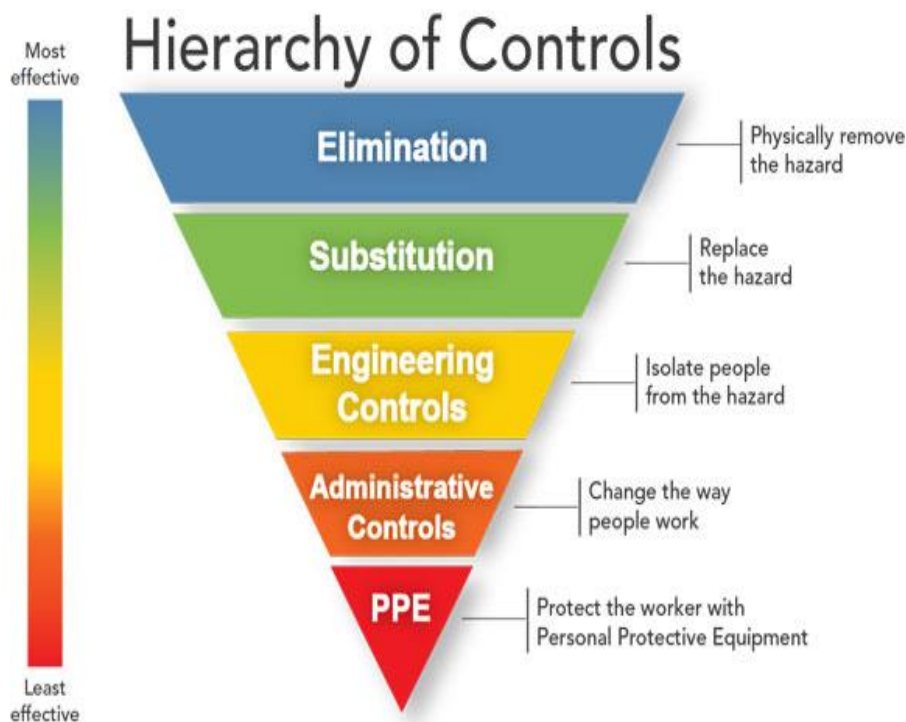

<https://commons.wikimedia.org/w/index.php?curid=55610678>

### Handling

Weights of Device:            Net: 185 kg                            Shipping: 200 kg                            Shipping with crating: 275 kg.



- Handling of the device to installation site must be with fork lift or hand pallet truck.
- Before unpacking device inspect carton for any damage relating to forklift forks and damage relating to device falling over or for evidence of top loading
- After unpacking the device, inspect all external panels for damage.
- Remove the 4 screws holding the device to the pallet.
- Follow your internal manual handling guidelines to manoeuvre the device off the pallet. The device can then be placed into position by fork lift or hand pallet truck.

### Disposal of Packaging

- Please dispose of packaging as per facility procedures or local government requirements.

### Disposal of Medical Device

- Please dispose of medical device as per state environmental regulatory requirements.



## 2.1 Service Connections

Provide 98mm OD duct to atmosphere.

Electrical Connection – 240 Volt 15 Amp

Plug into 15 Amp G.P.O.

## 2.2 Device Dimension and Clearances

DC12M

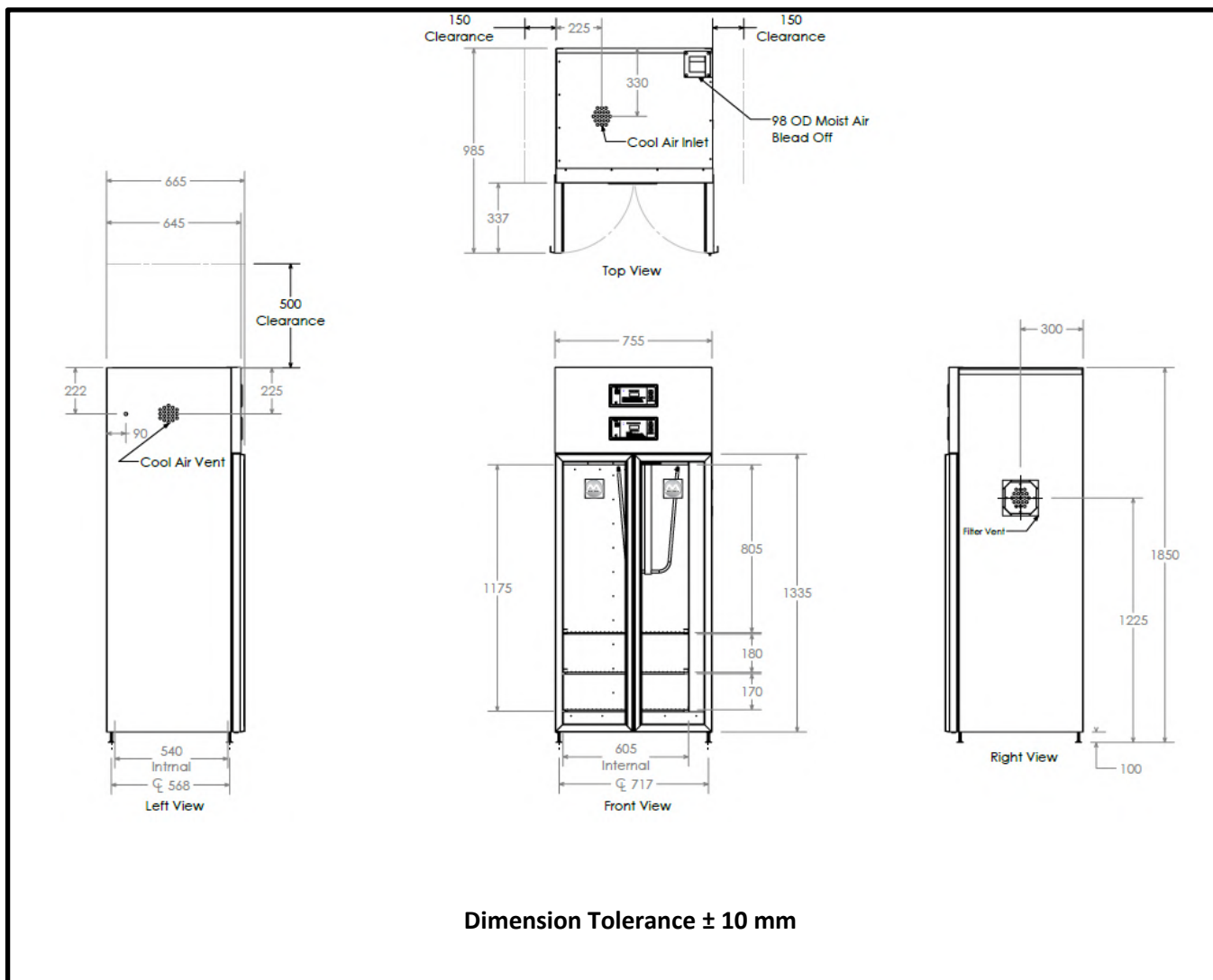

## 2.3 Wall Recessed Devices

Plug into standard 240 Volt outlet (plug shall be accessible after installation).

Outside dimensions for DC12M – 1850H x 755W x 665D.

Clearance space dimensions are required; at least 150mm per side and 500 mm on top.

Drying cabinet sides are to fit through the wall cavity, ensuring that the power cord and filter are not obstructed. Placement should be typically 150mm from the operating panel side doors. A 5-10mm gap between the side panel and the timber is required.



Clearance on the top of the Drying Cabinet needs to be typically 500mm. This allows access to replace the electric motor, heating elements etc. Allowing for this 500mm may require the facility to install a false panel in the dividing wall.

All electrical service work must be accessible through the top of the Drying Cabinet.

Position the Drying Cabinet in the cavity, ensuring that the doors can open and close with clearance for the doors at hinge point.



**Note:** This Drying Cabinet is not intended for use by persons (including children) with reduced physical, sensory, or mental capabilities, or lack of experience and knowledge.

Children should be supervised to ensure they do not play with the Drying Cabinet.

If the supply cord is damaged, it must be replaced by the manufacturer or its service agent or a similarly qualified person in order to avoid a hazard.



### 3.0 Maintenance

#### 3.1 Preventative Maintenance

Daily Wipe out inside doors and chamber with warm water and detergent.

Wipe over outside panels with stainless steel cleaner.

Monthly Remove Cabinet Air Intake Filter (Mid right-hand side panel) and clean, use a vacuum to clean the external side of the filter. (Do not use a mechanical cleaning attachment as this may damage the filtration material and affect the performance of the filter)

Half Yearly Check electrical connections.

Remove top panel and clean off accumulated dust and dirt.



Note: Disconnect power before removing top panel

Yearly Check and if necessary replace rubber in tube holding trays.

Replace HEPA Cabinet Air Intake Filter. (Part No. 87-3010SP)



#### 3.2 Trouble Shooting Guide

Problem	Probable Cause	Suggested Remedy
Display not on or won't turn on.	No Mains power supply. Power point not turned on. Display will not turn on. Faulty display board. Interconnecting harness failure. Relay board fault.	Check power supply and lead plugged in. Check power switched on. Press Standby button. Switch off power supply at main and call for Service. Switch off power supply at main and call for Service. Switch off power supply at main and call for Service.
Display turns on. (Runs for approximately ½ - 1 hour then turns off).	Fan failure.	Switch off power supply at main and call for Service.
Display is on but unit not heating.	Heating element failure. Relay board failure Thermostat cut-out switch open circuit.	Switch off power supply at main and call for Service.
Display indicates Ot	Fan Failure. Heating element on. Continuously unable to switch off. (Relay Board Failure)	Switch off power supply at main and call for Service. Switch off power supply at main and call for Service.
Display indicates O/C	Control Temperature Thermistor is broken or unplugged.	Switch off power supply at main and call for Service.
Display on but unit cooling down.	Heating element failure. Thermostat cut-out switch open circuit. Relay board failure.	Switch off power supply at main and call for Service. Switch off power supply at main and call for Service.



## 4.0 Technical Specification

### 4.1 Device Specifications

<b>Electrical Rating</b>	Volts	220-240V	
	Phase / Hz	1 ph. / 50 Hz	
	Amps	13.8 Amps	
<b>Environment operating conditions</b>	Temperature	+10°C to +25°C	
	Relative Humidity	+30% to +70%	
<b>Electrical Connection</b>	IEC Power Cord with 3 Pin Plug	15 Amp (into standard GPO 240 Volt)	
<b>Elements</b>	Rated	1500-watt x 2	
	Over temp cut out protection	Manual reset thermal cut-out switch NC 115°C Action 2 B, K	
<b>Control PCB</b>	Microprocessor Control Relay	PCB (SKCM325) Access via compatible RS232	
	Overtemp Protection	Electronic cut-out @ 5°C above set point	
<b>Cabinet Temperature Control</b>	Incremental 1°C – 70°C	Factory set at 50°C	
<b>Cabinet Secondary Overtemp Protection</b>	High Limit 80°C	Auto reset thermostat factory set 80°C Action 2 B	
<b>Materials</b>	Doors	Bi-parting, protruding 330mm out when open.	
	Door Gasket	Silicon Rubber	
	Cabinet	304/4 stainless steel	
<b>Air Circulation</b>	Air Vent spigot 98Ø outside	Automatic Damper Control, to be vented to outside atmosphere.	
	Air Filter	150mm x 150mm x 12mm – Mini Pleat H13 HEPA Filter	
	Air Bleed Off	Automatic Damper Control	
<b>HANDLING &amp; STORAGE CONDITIONS</b>	 Fragile	 Keep away from rain	 Do not stack
<b>DIMENSIONS &amp; WEIGHTS</b>			
<b>Weight</b>	Nett	Shipping	Shipping(crated)
	185 Kg	200 Kg	275 Kg
<b>Dimensions (W x D x H) (mm)</b>	755 x 665 x 1850 (mm)		1000 x 810 x 2100 (mm)



4.2 Wiring Diagram DC12M

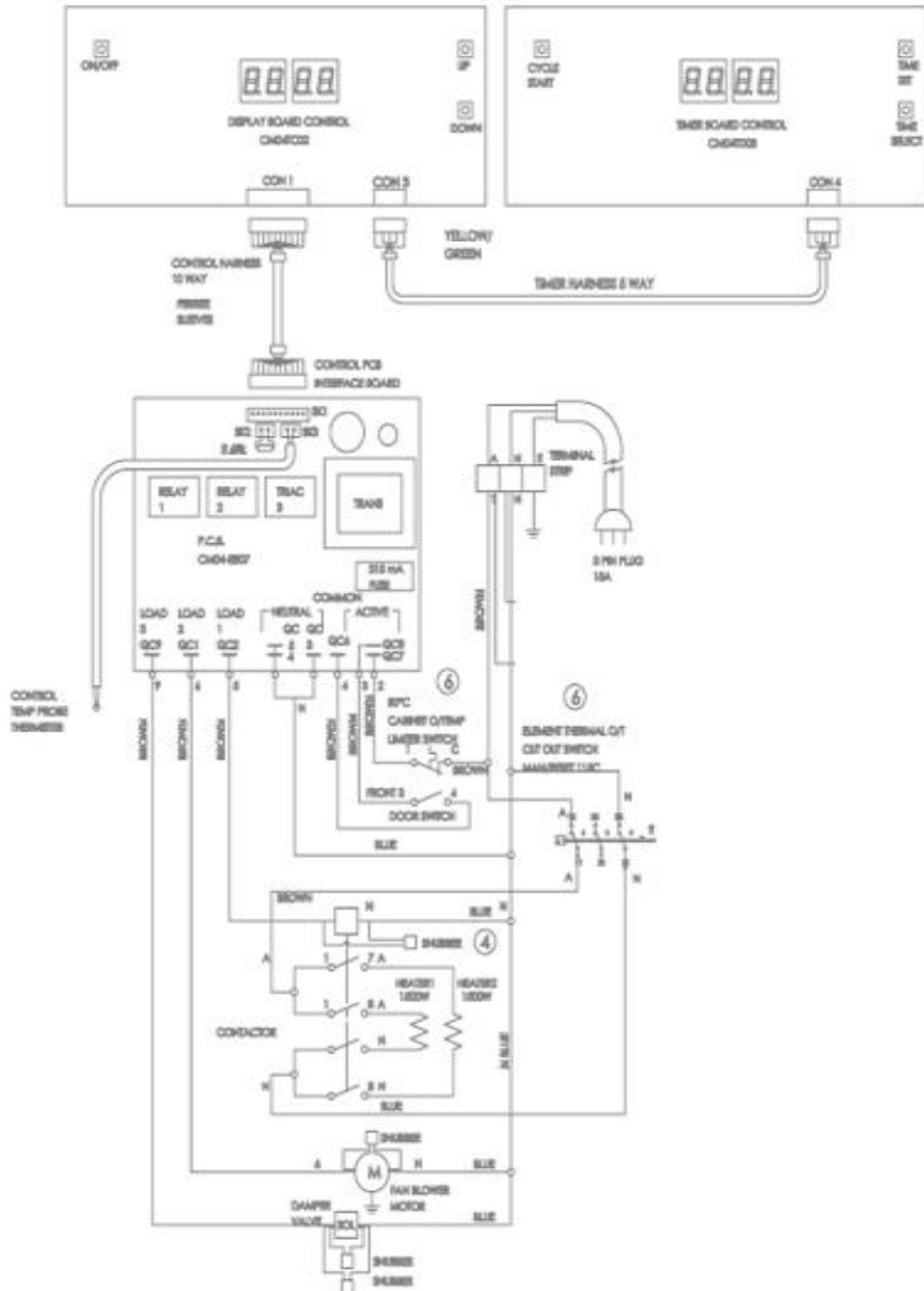





## Warranty Statement

This warranty is provided, and operates in addition to, the statutory warranties Malmét (Australia) Pty Ltd ("**Malmét**") provides to any consumer under the Australian Consumer Law (if applicable) or by virtue of any other applicable legislation.

Subject to the following conditions, we provide, from the date of purchase, the following warranty on Malmét devices and spare parts for products manufactured by Malmét and sold in Australia:

- Functional components found within the device to be defective in workmanship or material will be repaired or replaced free of charge subject to the periods of warranty specified in the table below.
- A decision regarding whether the defective components will be repaired or replaced will be determined at the sole discretion of Malmét or its authorised agents or representatives.
- The structural warranty covers any structural components within the device, which fail to perform their intended function due to faulty manufacture or deterioration within the warranty period.
- Parts replaced in devices under warranty are warranted for the balance of the original warranty period for that device.

Malmét Devices	
Device Components	Parts & Labour
Structural Guarantee	2 Years from Date of Purchase
All other components	2 Years from Date of Purchase

Malmét Spare Parts
1 Year from Date of Purchase

The installer is responsible for the correct installation, start up and demonstrating the operation of the product. They are also responsible for issuing the relevant certificates of compliance (these may differ from state to state).

### CONDITIONS AND EXCLUSIONS

- Device must be installed and commissioned according to Malmét's instructions (outlined in Malmét Operation, Maintenance and Installation Manual) and operated to the purpose it was designed.
- Device must be serviced as instructed in the Operation, Maintenance and Installation Manuals.
- To the extent permitted by law, this warranty shall not cover damage, malfunction or failure resulting from accident, misuse or misapplication, improper or unauthorised repair, neglect or modification or use of unauthorised replacement parts or accessories, inclusive of detergent, or improper voltage. The warranty may be void if the serial number is removed or altered.
- Parts damaged in transit back to Malmét Leeton due to poor packaging could result in warranty claim being rejected in part or in full.
- Any part tampered with or which has been altered by unauthorised repairs and/or modifications will be rejected under a warranty claim to the extent permitted by law (to the extent the Australian Consumer Law applies, Malmét will assess the extent to which the tampering or unauthorised repairs contributed to the failure).
- Reasonable access must be allowed for maintenance. If any additional equipment is needed to provide access to the device, this must be provided (and paid for) by the owner.



- It is the owner's responsibility to provide safe access to the device. Malmet, or any of its authorised service agents, may refuse to perform maintenance or warranty work if access is unsafe, as determined by Malmet or any of its authorised service agents acting reasonably.
- Should a warranty claim be rejected you will be advised in writing with a full explanation of our reasons.
- Malmet have a Warranty Claim Procedure that is fair to our customers and provides an efficient system of replacement and/or repair of faulty parts. If at any time you believe we are not meeting our commitment to you please contact Malmet Head Office via email: [info@malmet.com.au](mailto:info@malmet.com.au)
- To the extent permitted by law, no responsibility will be accepted for outside elements including, but not limited to storms, pest and vermin that may cause damage to the device.
- To the extent permitted by law, no responsibility will be accepted for damage incurred as a result of, or incidental to, electrical surges or brown outs or for any other consequential damages.
- If there is no certificate of compliance for plumbing or electrical, Malmet reserves the right to refuse service on non-compliant installations.
- To the extent permitted by law, claims for damage to contents, carpet, ceilings, foundations or any other consequential loss either direct or indirect resulting from, power spikes, incorrect operation, incorrect installation, faulty product or any other cause, are excluded.
- This warranty, and to the extent permitted by law, any warranties owed by Malmet under the Australian Consumer Law or other applicable legislation, are not transferrable and cannot be sold, assigned or transferred in any other way from the purchaser to any other person.
- To the extent permitted by law, unauthorised use of any parts that were not supplied or approved for use in the applicable device by Malmet will result in this warranty and any warranty claims applicable to that device being void.
- Warranty labour (service work) shall not include devices located outside of city metropolitan areas of Melbourne, Sydney, Adelaide, Perth and Brisbane. Costs outside these areas shall be borne by the owner. The owner shall be notified of this prior to the warranty call out.
- Warranty labour (service work) shall be performed during normal business hours (Monday – Friday 7am – 4pm), excluding public holidays.
- Warranty labour (service work) performed outside of normal business hours, shall be charged at Malmet's or its authorised representative or agent's standard after-hour labour rates.
- Warranty relating to spare parts covers parts only and does not include any associated labour costs.

To the extent permitted by law, a charge will be made for work done or a service call made where:

- There is no fault apparent with the device, as determined by Malmet or its authorised representative or agent acting reasonably.
- The defective operation of the device is due to failure of electricity or water supply.
- Defects are caused by neglect, incorrect application, abuse or by accidental damage of the device.
- An unauthorised person has attempted to repair the device.
- Harsh environmental situations including, but not limited to, water quality that may cause the water tank damage cannot be covered under this warranty

**HOW TO MAKE A CLAIM UNDER THIS WARRANTY**

If you believe there is a defect in a device you have purchased from Malmet, you must notify Malmet in writing of such defect, by sending an email (**Notice of Defect**) to [info@malmet.com.au](mailto:info@malmet.com.au) prior to the expiration of the applicable warranty period set out in this warranty.

For the avoidance of doubt, Malmet must receive your Notice of Defect prior to the expiration of the warranty period.

To the extent permitted by law, Malmet will not reimburse you for any expense you incur in claiming or attempting to make a claim for repair or replacement of a component under this warranty.

**Please complete details below:**

<b>Date Purchased:</b>	<b>Warranty Expiry Date:</b>
<b>Sold To:</b>	<b>For Service Contact:</b>

**PROOF OF PURCHASE**

Please retain your proof of purchase (receipt, invoice or commissioning certificate is accepted).

**E.&O.E.**

In the interest of continued product improvement, Malmet reserves the right to alter specifications without notice.

**AUSTRALIAN CONSUMER LAW DISCLAIMER (APPLIES ONLY TO THE EXTENT YOU ARE A 'CONSUMER' WITHIN THE MEANING OF THE AUSTRALIAN CONSUMER LAW):**

Malmet goods come with guarantees that cannot be excluded under the Australian Consumer Law. You are entitled to a replacement or refund for a major failure and for compensation for any other reasonably foreseeable loss or damage. You are also entitled to have the goods repaired or replaced if the goods fail to be of acceptable quality and the failure does not amount to a major failure.





Manufactured by

**Malmart (Australia) Pty Ltd**

ABN 95 001 717 791

[www.malmart.com.au](http://www.malmart.com.au)

Queensland Distributor

**EVOCARE AUSTRALIA PTY LIMITED**

A.B.N. 98 078 566 604

Trading as **EVOCARE** and **L&M EQUIPMENT**

P.O. Box 145, Everton Park Qld. 4053

Ph: 07 3355 8000

Website: <http://www.evocare.com.au>

Email: [sales@evocare.com.au](mailto:sales@evocare.com.au)

[workshop@evocare.com.au](mailto:workshop@evocare.com.au)

[warehouse@evocare.com.au](mailto:warehouse@evocare.com.au)

[accounts@evocare.com.au](mailto:accounts@evocare.com.au)

