

User Instruction Manual & Warranty

Oxford® 4-Point Adaptive Power Cradle

To avoid injury, read user manual prior to use.

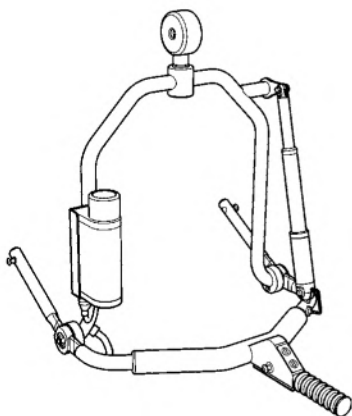

Contents

1. Installing your Oxford 4-point Adaptive Power Cradle	3
2. Component Parts.....	4
3. Assembly Instructions (connection and removal).....	4
4. Sling Attachment	6
5. Safety Precautions	7
6. Cradle Operation	8
7. Service & Maintenance	11
8. Electrical Specification.....	14
9. Warranty	15

1. Oxford 4-point Adaptive Power Cradle

The Oxford Presence lift is fitted with a 6-point spreader bar as standard and the Stature lift is fitted with a 4-point cradle as standard (see fig. 1).

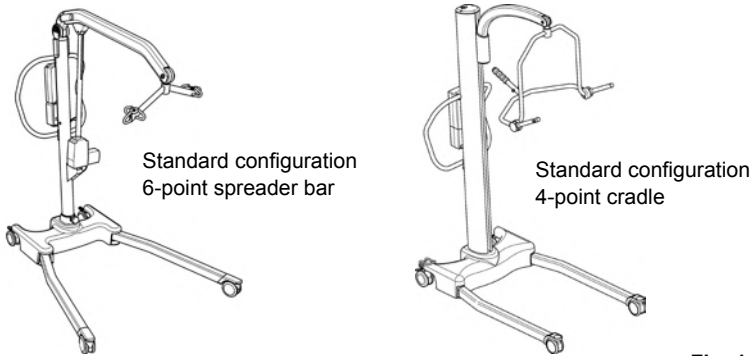

Fig. 1

As an accessory, you can retrofit your standard spreader bar/cradle with an Adaptive Power Cradle (see fig. 2).

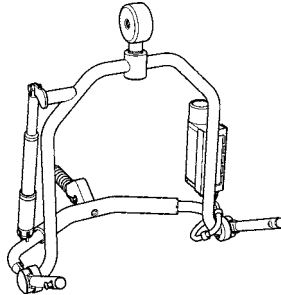

Fig. 2

This accessory utilises Oxford Comfort slings featuring the Securi3 safety clip system (see fig. 3).

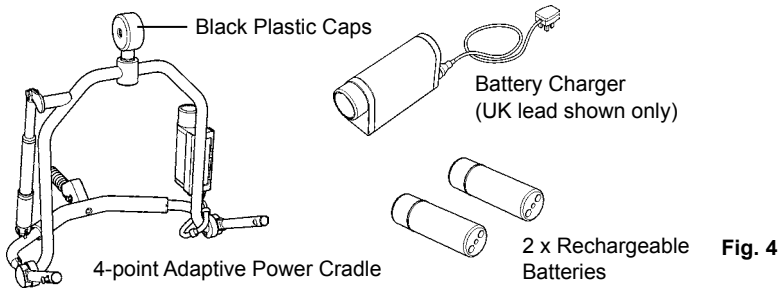

Fig. 3

2. Component Parts: Adaptive Power Cradle

The following components are included with your 4-point Adaptive Power Cradle (see fig. 4).

1. 1 x 4-point Adaptive Power Cradle
2. 1 x Battery charger
3. 2 x Rechargeable batteries, NiMH
4. 2 x Black plastic caps for Stature and Presence boom
5. 1 x User/service manual (not shown)



3. Assembly Instructions

Assembly is quick and easy but it is important that you follow the procedure carefully.

FOLLOW THESE INSTRUCTIONS EXACTLY:

Removal:

To attach your 4-point Adaptive Power Cradle you must first remove the old spreader bar/cradle from the lift. This is achieved by removing the quick-release pin that retains the non-powered spreader bar/cradle (see fig. 5). A small flat blade screwdriver or similar is the only tool required.

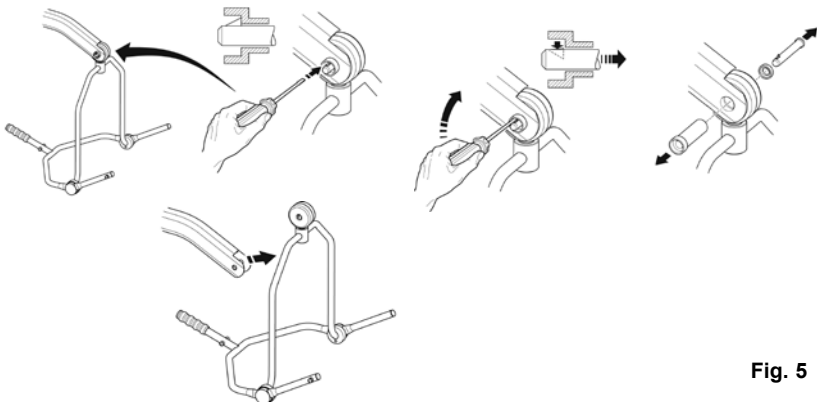

CAUTION: Prior to removing the quick release pin, the cradle needs to be supported by a stationary object such as a workbench or table. This will prevent the cradle from dropping suddenly which could result in an injury or damage to the cradle.

Connection:

To connect, raise the 4-point Adaptive Power Cradle up towards the boom slot. Insert the pin sleeve through lift boom, the black plastic end cap* and the cradle king pin. Once the pin sleeve has been installed and is supporting the weight of the Adaptive Power Cradle, re-insert the quick release pin fully into the sleeve until it locks into position (See fig. 6).

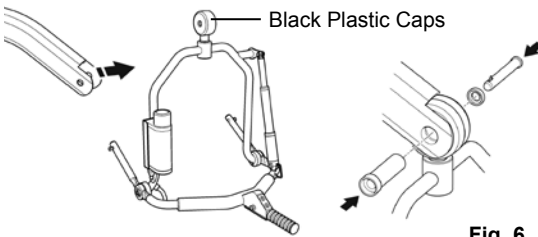

Fig. 6

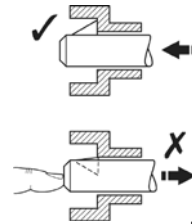

Fig. 7

To verify that the pin is securely fitted, press your finger into the barbed end. If the pin remains stationary, the lift is safe to use (See fig. 7).

⚠ WARNING!

YOU MUST CHECK THAT THE PIN IS SECURELY FITTED; a noticeable “click” will sound when the connection has been made secure.

*Ensure you use the correct version of the black plastic cap for your lift, as 2 are supplied. Check the cap width against your lifts boom before fitting.

4. Sling Attachment

Attachment of the Comfort sling to your Adaptive Power Cradle:

The Comfort sling attaches to the cradle studs via the Securi3 safety clip system (shown below); each sling is supplied with instructions. Please study the instruction guide before use (See fig. 8).

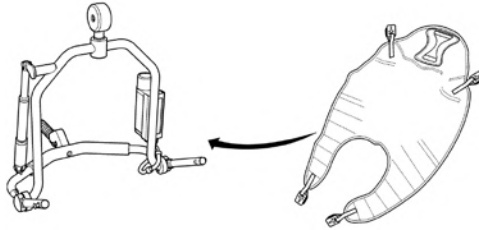

Fig. 8

Example of Securi3 safety clip system. The 3 key stages assure patient and carer of complete safety and comfort throughout the transfer (see fig. 9).

5. Safety Precautions

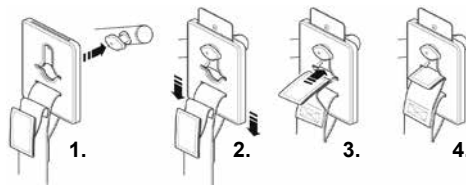

Fig. 9

1. Attach clip to lug
2. Pull plastic clip down to secure
3. Feed green 'safe' tab through slot
4. Sling is attached and ready to use

⚠ WARNING!

- Before using your 4-point Adaptive Power Cradle ensure the quick release pin is **FULLY ENGAGED** as shown in figure 6 and 7 on page 5.
- The Oxford 6-point spreader bar and the Oxford 4-point Adaptive Power Cradle (power and non-power) are only compatible with the Oxford Presence and Stature lifts. Do not use this cradle or spreader bar with any other manufacturer's lift or slings.

- **When placing the cradle and sling in the most upright position do not leave the patient unattended. The patient could slump forward in the sling, which could result in an injury to the patient.**
- **Do not use a sling unless it is recommended for use with the cradle/lift.**
- **Always check that the sling is suitable for the particular patient and is of the correct size and capacity.**
- **Never use a sling that is frayed or damaged.**
- **Always fit the sling according to the user instructions provided (sling user instructions).**
- **Always plan your lifting operations before commencing.**
- **Always check that your Oxford 4-point Adaptive Power Cradle is in good working order prior to any lifting operation.**
- **Always use the 4-point Adaptive Power Cradle in a clean, dry and temperature controlled indoor environment.**

6. Cradle Operation

Hand Control:

Operating the 4-point Adaptive Power Cradle is a very easy process. Once the patient has been placed in the sling and the sling has been attached to the Adaptive Power Cradle, the cradle is positioned by using the hand control located in the cradle handle (see fig. 10).

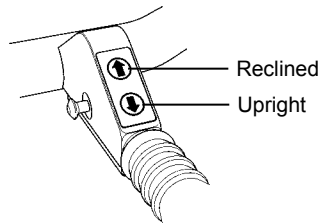

Fig. 10

Pressing the **“Up”** arrow button will move the patient into a reclined or lying position.

Pressing the **“Down”** arrow button will move the patient into an upright or sitting position.

The 4-point Adaptive Power Cradle can be positioned in incremental movements or in one constant motion. This ensures the patient is positioned in the optimum profile for their maximum comfort.

⚠ WARNING!

When placing the cradle and sling in the most upright position do not leave the patient unattended. The patient could slump forward in the sling, which could result in an injury to the patient.

Battery & Control Box:

The 4-point Adaptive Power Cradle requires a minimum of maintenance but it is very important to perform regular maintenance and to have a thorough understanding of the control system.

The control box has been designed to provide audible signals. The signals are indicated with long, short or multiple “beeps”.

1. **Power On** (Power is on when the battery is inserted): One extended “BEEP”
2. **Sleep Mode**: Two short “BEEPS”
3. **Low Battery**: Two short “BEEPS” repeated every 24 seconds. (charge battery)
4. **Start Operation**: Two “BEEPS” (low voltage, charge battery soon)
5. **During Operation**: One long BEEP (the battery charge is too low; only a reclined position can be achieved). Replace the battery with a fully charged battery.

Charging Instructions:

To charge the battery, follow the instruction below:

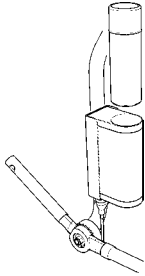

Fig. 11

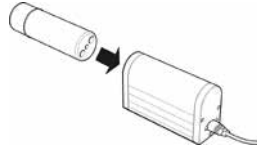

Fig. 12

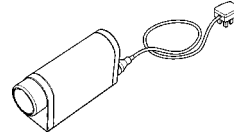

Fig. 13

(UK version shown)

1. Remove the battery from the cradle (see fig. 11). The battery is retained by a magnetic force. Simply pull the battery straight out of the control box on the cradle.
2. Connect the power lead into the charger.
3. Place the battery in the charging unit (see fig. 12). The battery is held in place by a magnetic force and will automatically align itself in the charger unit.
4. Plug the charger into the mains power outlet (see fig. 13). An amber light will illuminate, indicating there is power to the charger.
5. A green light will begin to “flash” indicating that the battery is being charged. The amber light remains constantly illuminated.
6. Once the green indicator light stops flashing and remains illuminated, the battery is fully charged and may be returned to service.
7. To return the battery to service, switch off (UK/EU) the mains supply and remove the battery from the charging unit. Fit the battery into the control box on the cradle. One long “BEEP” will indicate that the battery has been properly placed in the control box and the cradle is ready for use.

NOTE: Ensure the batteries are fully charged prior to using your 4-point Adaptive Power Cradle for the first time.

NOTE: The cradle will sound a single “beep” after the battery has been removed. The “beep” will occur on a regular interval for several hours.

⚠ WARNING!

- **KEEP the battery fully charged. Place the battery on charge whenever it is not in use. If it is more convenient to do so, place on charge every night. The charger WILL NOT allow the battery to overcharge.**
- **Battery or charger is not to be opened by unauthorized personnel. (Contact Joerns Healthcare or your distributor for warranty and repairs).**
- **Do not touch battery/charger terminals.**

- **Never run the battery completely flat. As soon as the audible warning sounds, complete the lifting operation in hand and place on charge.**
- **CAUTION: Never store the battery for long periods without regular charging throughout the storage period. This can result in damage to the battery preventing it from being charged correctly.**
- **Always make sure the mains power is switched off before connecting or disconnecting the battery (UK/EU).**
- **CAUTION: Never leave the battery in the charging unit with mains power off (UK/EU) or un-plugged from the wall outlet (US).**
- **CAUTION: Never leave the battery charger switched on with the battery removed.**
- **Do not pull on the power lead cable when disconnecting from the charger. Always remove by grasping firmly the connector plug at the charger end.**

7. Service and Maintenance Schedule

	Initially	Before Use	Service Intervals
1. Check for freedom of rotation (power cradle)	✓	✓	✓
2. Check for wear on the central pivot point (the pivot pin located in the cradle frame)	✓		✓
3. Check for firm attachment to the boom of the lift	✓	✓	✓
4. Check for wear of the boom and quick release pin on the lift	✓		✓
5. Check the actuator for correct operation listen for unusual noise	✓	✓	✓
6. Lubricate the pivot joints, including boom and cradle			✓
7. Inspect pivot joints, including boom and cradle for excessive wear. Replace as required			✓
8. Check power cable is firmly attached to the charger		✓	

Cleaning

The Oxford 4-point Adaptive Power Cradle will when necessary require cleaning. It can be cleaned with warm water or a disinfectant cleaning fluid.

CAUTION: Harsh chemicals may dull or remove the paint/finish from the cradle.

WARNING

DO NOT spray or submerge the lift in any liquid.

Service Parts:

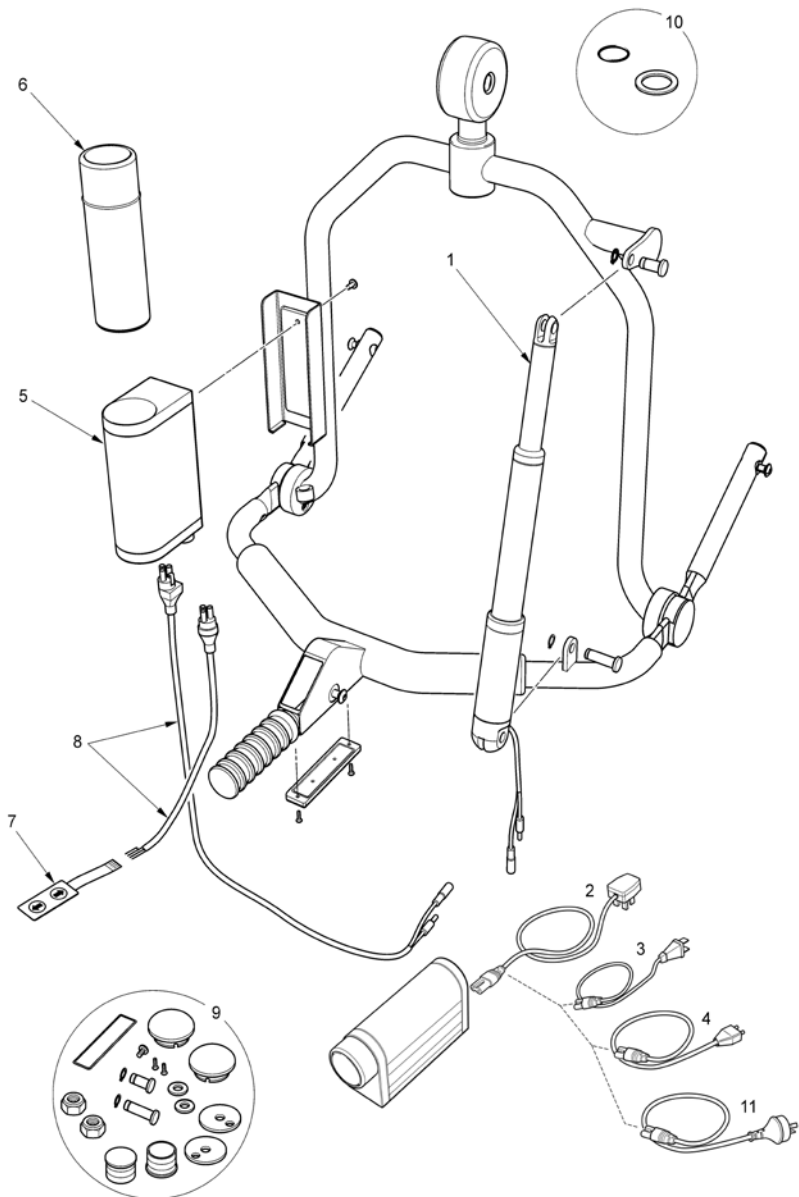

Fig. 14

No.	Part No.	Description
1	0Y0457	Actuator
2	0Y0459	Battery charger with UK lead
3	0Y0460	Battery charger with EU lead
4	0Y0458	Battery charger with US lead
5	0Y0461	Control box
6	0Y0462	Battery
7	0Y0463	Hand switch assembly
8	0Y0464	Wire harness between control box, actuator and switch
9	0Y0465	Hardware (fixings)
10	0Y0380	Washer and O-ring kit
11	0Y0761	Battery charger with AU lead

8. Electrical Specification

Batteries	24VDC, rechargeable NiMH sealed
Battery capacity.....	1400mAh
Charger rated Input.....	100 - 240V AC// 24 VDC 50/60 Hz Max. 75mA
Charger rated Output.....	Max 28,4VDC

Electric Shock Protection

Charger.....	Class II
--------------	----------

Degree of shock protection

Charger.....	TYPE B
--------------	--------

Environmental Conditions

Outside this environment functionality and safety may be compromised

Operating

Temperature.....	-5C to +70C
------------------	-------------

Storage

Temperature.....	-40C to +85C
------------------	--------------

IP Ratings

Control Box.....	IP50 (with battery inserted)
Actuator.....	IP66
Charger.....	No rating (not to be used in wet environment)
Battery.....	IP50
Control Switch	IP67

Duty Cycle

Actuator.....	10% (2min./18min.)
Charger.....	Approx. 6 hrs

Acoustics

A-Weighted sound power level	51.5 dB (A)
------------------------------------	-------------

Weight

Cradle including battery	9.5 kg
Battery	0.5 kg

9. Warranty

Joerns Healthcare has an established network of reputable sales representatives, distributors and dealers who will be pleased to handle all your purchasing, warranty, repair and maintenance inquiries. Our products are guaranteed for a period of 24 months from the date of manufacture or 24 months from the date of purchase if commissioned by an authorized dealer. This guarantee covers the major structure including the 4-point cradle, actuator, control box and control switch (Batteries are covered for a period of 90 days from purchase).

We recommend that all of our products be commissioned by your dealer, an authorized service agent or by qualified maintenance personnel. The dealer or distributor operates the warranty Programme; so it is important to keep a record of their name address and telephone number so they can be contacted should any problem arise (UK customers only).

If you are in doubt where your lift was purchased, Joerns Healthcare can trace the supplier if you provide the serial number of the cradle, which is situated under the handle that houses the control switches.

For any details/queries relating to above please contact your customer service agent.

REMEMBER Contact Joerns Healthcare or your distributor/customer service agent for purchases, warranty, repairs, servicing and certified maintenance.

Distributor

EVOCARE AUSTRALIA PTY LIMITED

A.B.N. 98 078 566 604

Trading as **EVOCARE** and **L&M EQUIPMENT**

P.O. Box 1144, Stafford Qld. 4053

Ph: 07 3355 8000 Fax: 07 3355 5043

Website: <http://www.evocare.com.au>

Email: sales@evocare.com.au

workshop@evocare.com.au

warehouse@evocare.com.au

accounts@evocare.com.au



Joerns Healthcare Limited
Drakes Broughton Business Park, Worcester
Road, Drakes Broughton
Pershore, Worcestershire, WR10 2AG
United Kingdom
(T) 0844 811 1156 • (F) 0844 811 1157
www.joerns.co.uk • email: info@joerns.co.uk